

MODULETA



**ZAHRADNÍ SEDAČKA
TROJSEDÁK**

www.MODULETA.cz

Princip skládání v konceptu MODULETA je založen na spojování jednotlivých částí pomocí závitových tyčí, které jsou vždy ukončeny maticí a krytkou. V manuálu jsou závitové tyče označeny délkou v mm. Prosím, dodržujte rozmístění a délky jednotlivých tyčí. Na jednu stranu tyče navlékneme podložku a ukončíme samojistící matkou. Následně navlékáme jednotlivé části dle konkrétního postupu v manuálu výrobku.

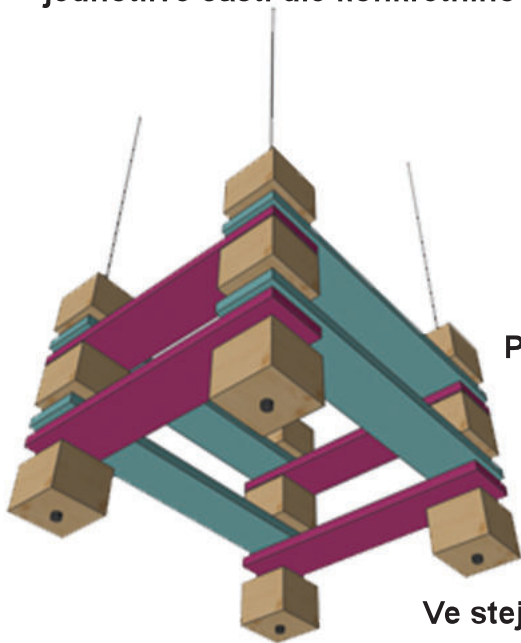
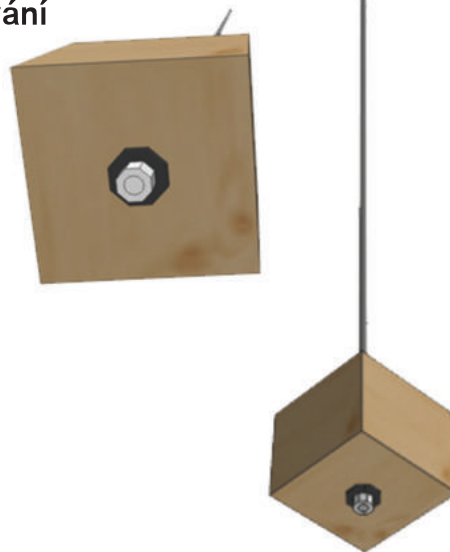

Postupem přidáváme jednotlivé komponenty, které navlékáme na závitové tyče díky vyvrtaným otvorům.

Věnujte prosím pozornost přesnému určení dílů.

Manuál vás vede krok za krokem.

V levém horním rohu je vyobrazen prvek (deska, špalek) s počty, druhem (klasický nebo zahlubžený otvor) a umístěním jednotlivých děr.

Ve stejném barevném odstínu jej naleznete umístěn v dané sestavě.

V průběhu skládání mohou být jednotlivé díly vyoseny. Toto vyosení upravíte těsně před finalizací výrobku a utáhnutím horní matice.

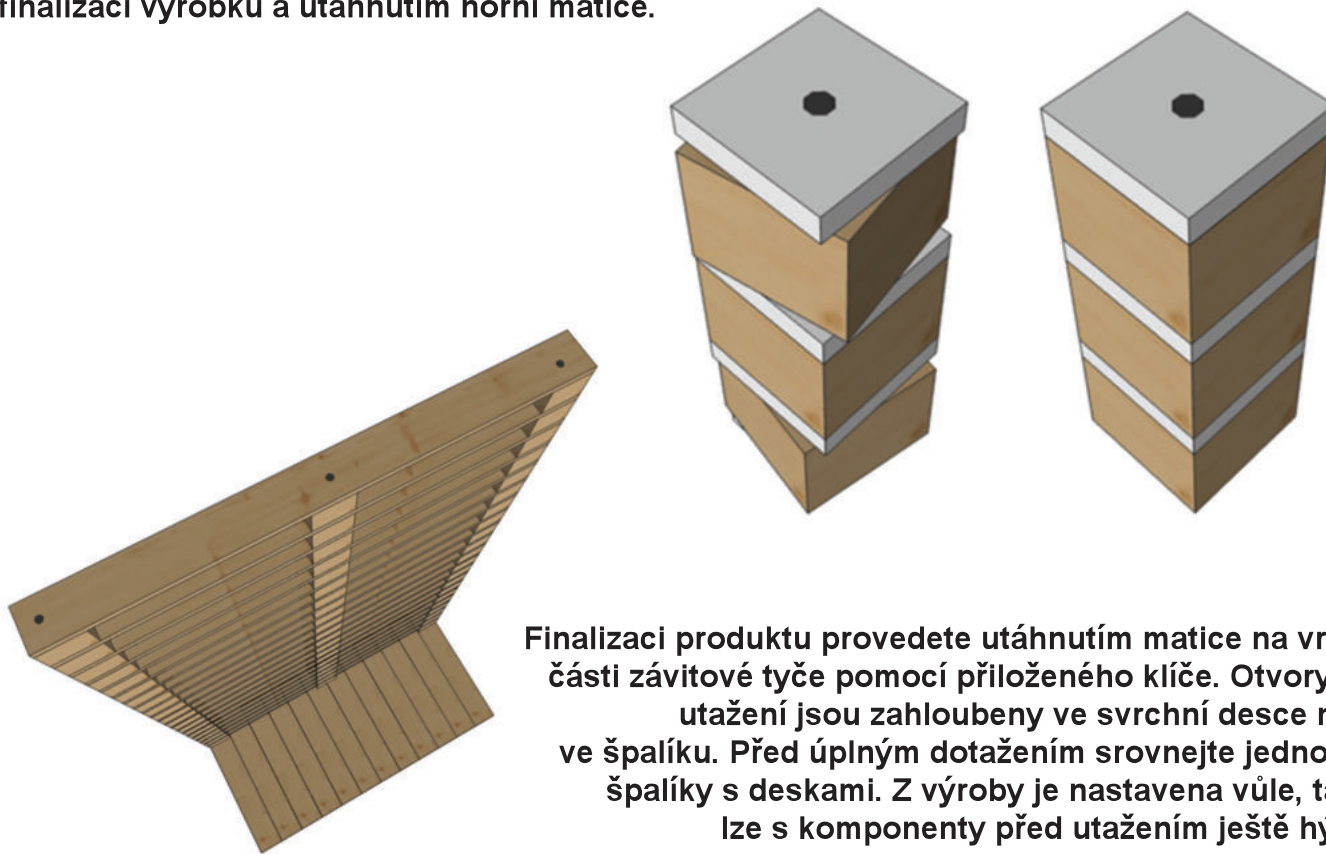

Finalizaci produktu provedete utáhnutím matice na vrchní části závitové tyče pomocí přiloženého klíče. Otvory pro utažení jsou zahloubeny ve svrchní desce nebo ve špalíku. Před úplným dotažením srovnejte jednotlivé špalíky s deskami. Z výroby je nastavena vůle, takže lze s komponenty před utažením ještě hýbat.

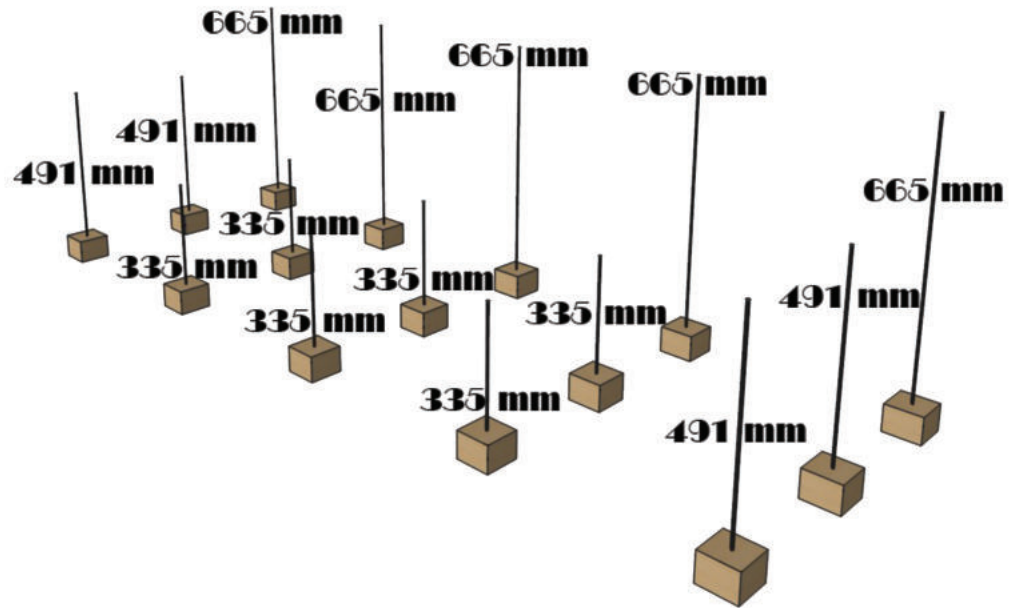

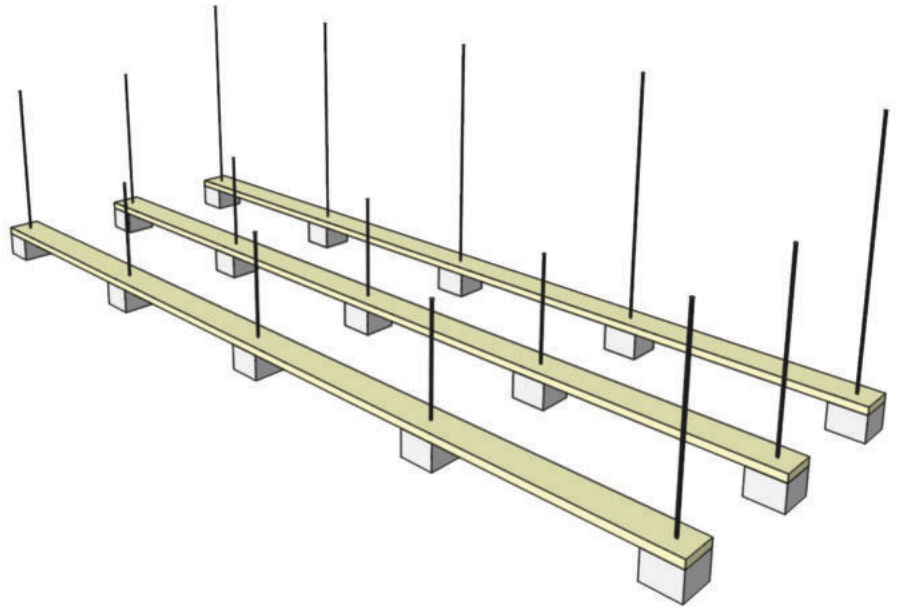

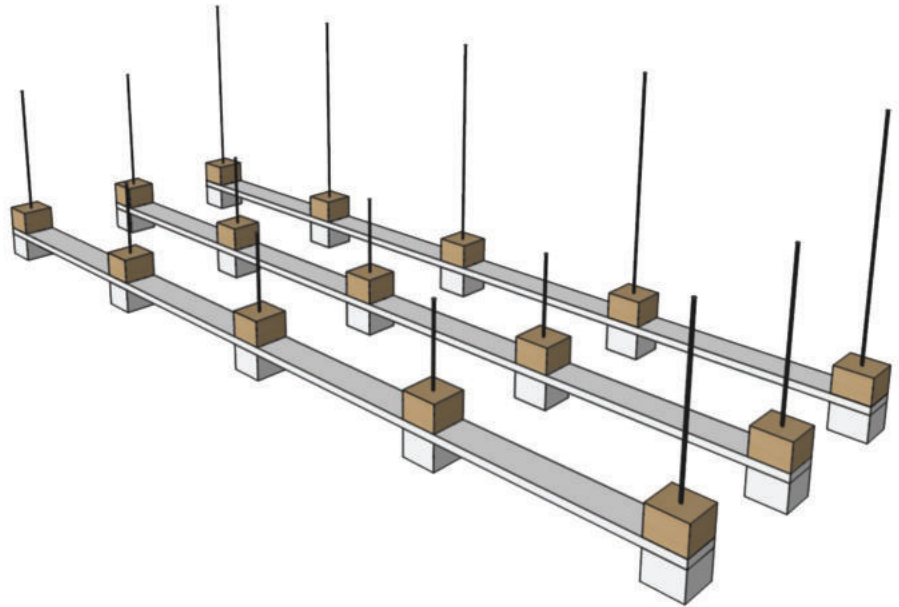

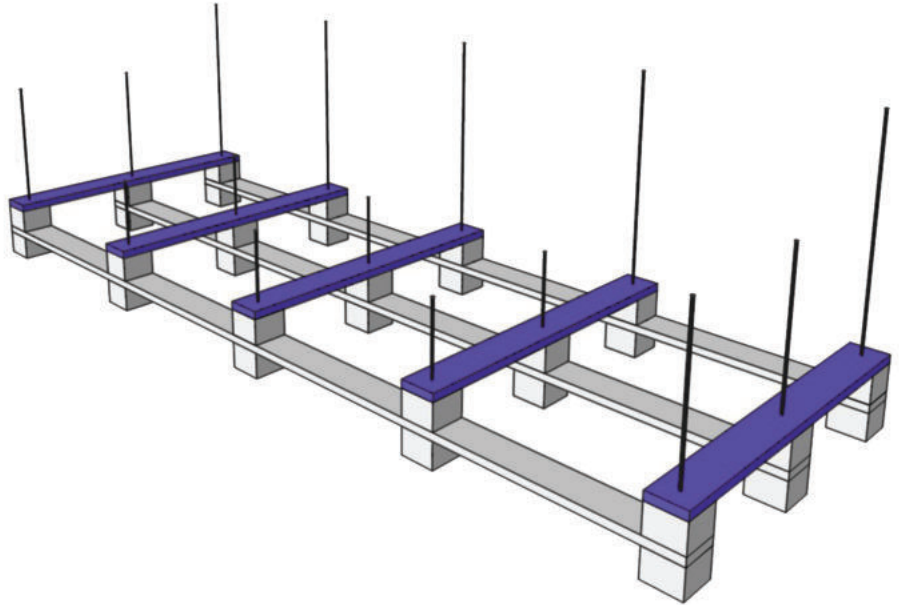

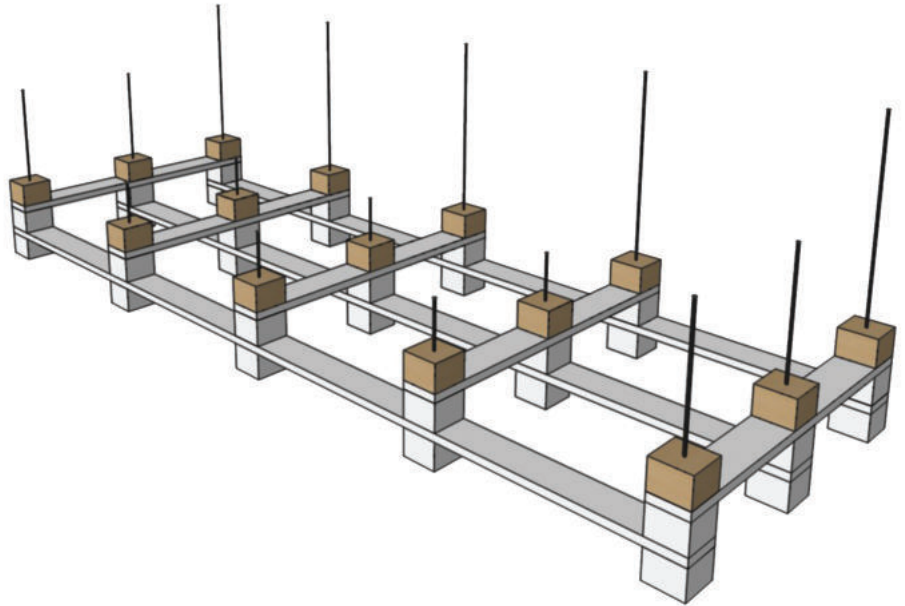

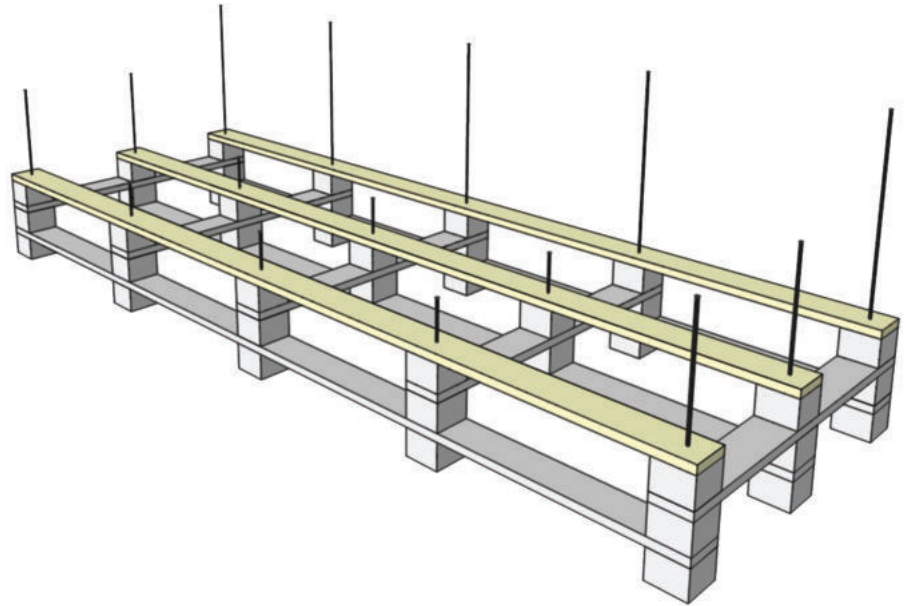

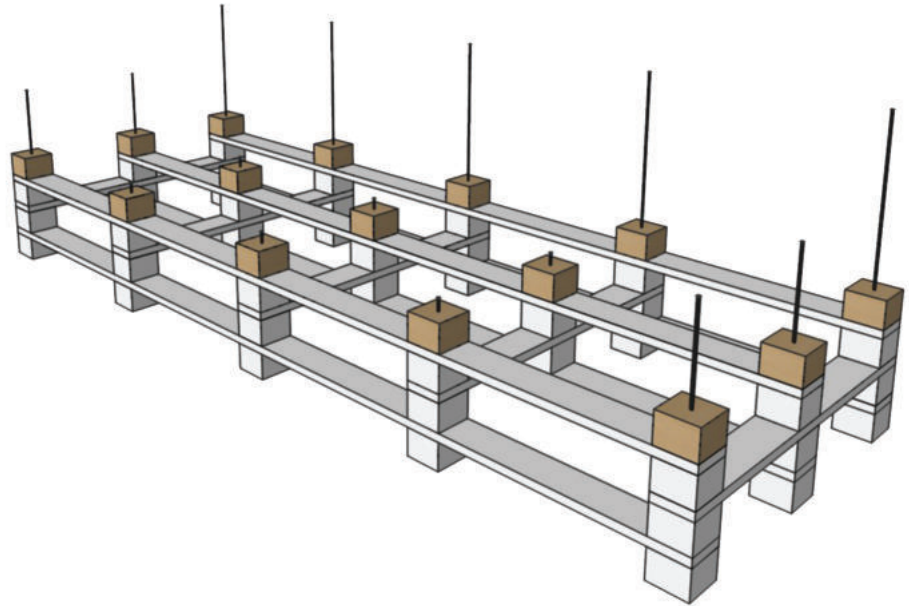

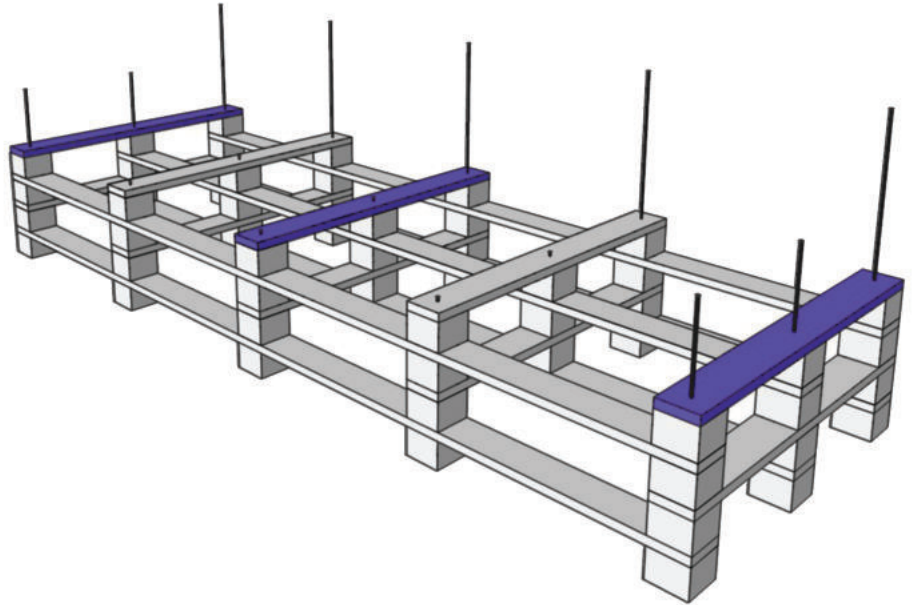
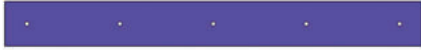

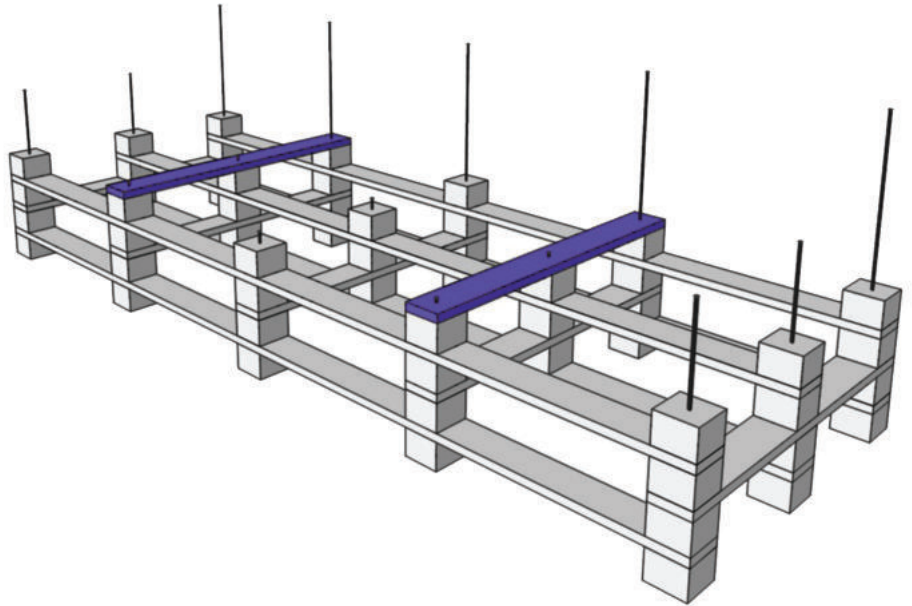

6x

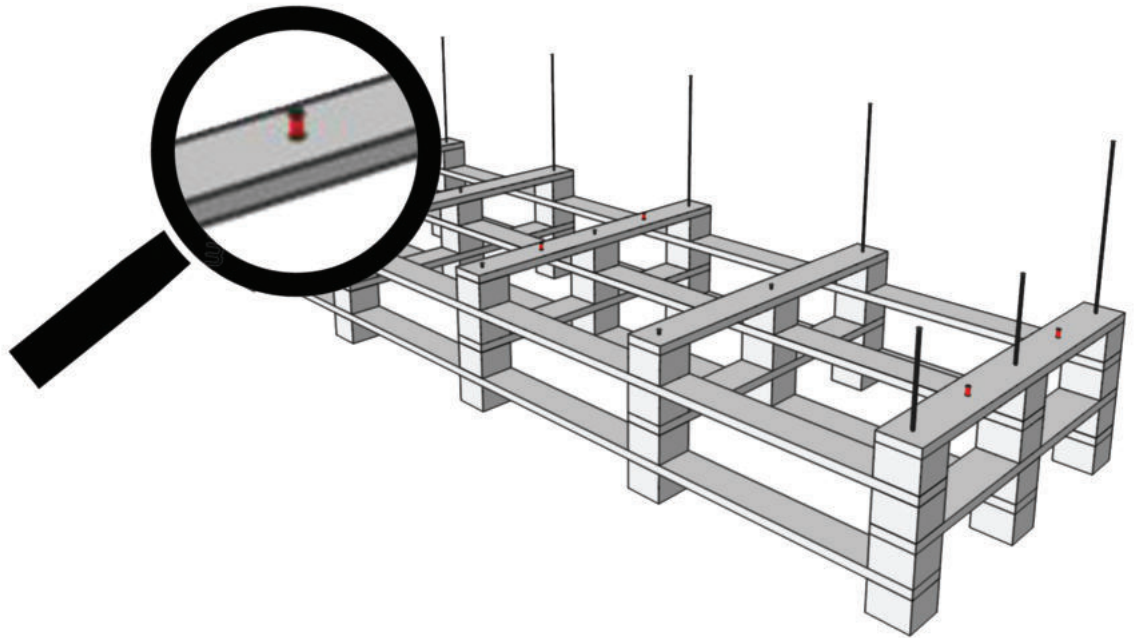

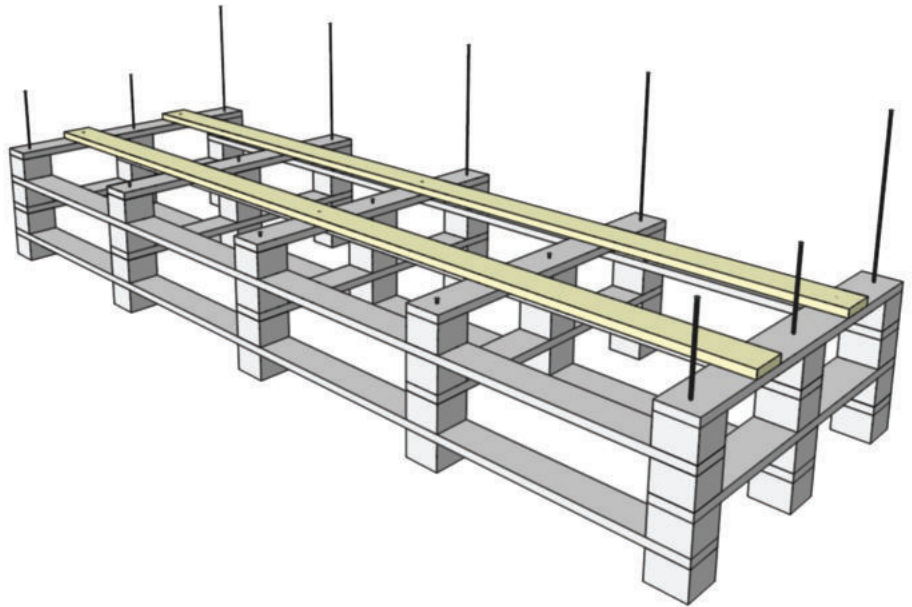

• • • • • **2x**

• • • • • **1x**

